

Split Ferrite Suppressors for Round Cables

Electronic cables and wires, by virtue of their length-to-width ratios, are perfect natural antennas. In the presence of high speed microprocessor signals,

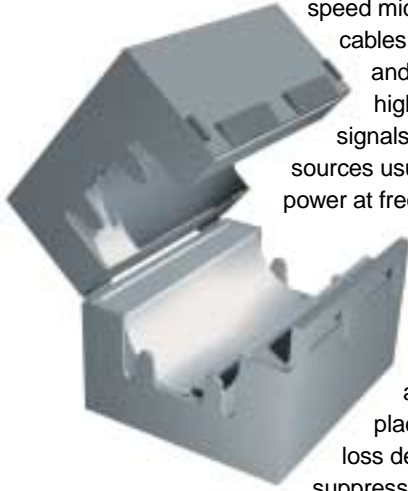

cables will conduct, radiate and/or receive unwanted high frequency interfering signals. Radio interference sources usually radiate their RFI power at frequencies above 30

MHz by way of the main cabling, which acts as an antenna. Control of radio interference can be assured by proper placement of an insertion loss device, such as a ferrite suppressor. Any device used to

block an RFI signal between its source and a receiver is an electromagnetic interference (EMI) shield. The measure of this ability to attenuate RFI is shielding effectiveness, "SE", which is expressed in decibels, "dB", the ratio of field strength on one side of the shield to the other side.

One of the most versatile and cost effective shielding methods that can be used today is the API Delevan bisected ferrite cable snap assembly. The bisected styling, or familiar clamshell enclosure design offers the ultimate in adaptability. The RF absorbing material interacts directly with unwanted high frequency energy and dissipates it effectively while allowing data signals to pass unimpeded.



Bisected ferrites have a concentrated, homogeneous magnetic structure with high permeability. These are consistently stable at +20°C to +60°C and provide RF suppression without eddy current losses.

AIR GAP EFFECT

The air gap in bisected ferrites actually extends current carrying capabilities with only an extremely small reduction in impedance versus solid ferrites of the same size. The gap is magnetically insignificant while it is electrically significant as a discontinuity, thereby accommodating more current.

POSITION OF SUPPRESSOR

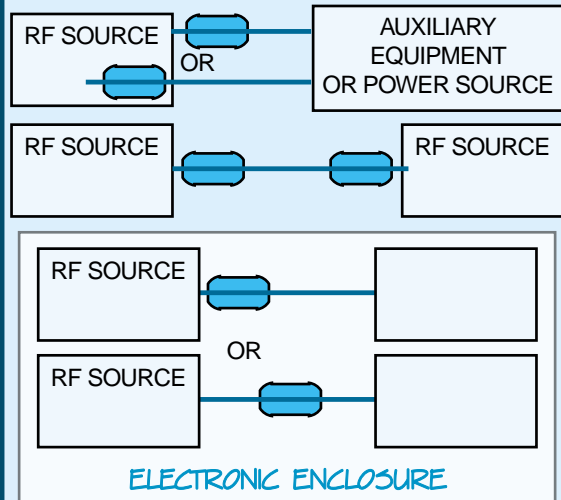

POSITION OF SUPPRESSOR The suppressor should normally be located close to the cable termination where it exits the enclosure. Where a cable connects two enclosures containing RF sources, a suppressor on each end may be required. For circuits within an enclosure, a position close to the RF is best. However, other locations along the circuit may work as well.

Material and U.L. Data API-1 Material, see characteristics and information on page 121.

Continued on next page

BF Series

Suppressors for Round Cables

DIMENSIONS
Inches ± 0.04; mm ± 1.0

IMPED-
ANCE
(OHMS) *

PART NUMBER
UNITS
BODY TYPE

A

B

C

D

L

25 MHz

100 MHz

SERIES BF - FOR ROUND CABLES

PART NUMBER	UNITS	BODY TYPE	A	B	C	D	L	25 MHz	100 MHz
BF2930	in. mm	A	1.16 29.6	1.20 30.5	0.51 13.0	1.30 33.0	—	155	257
BF2223	in. mm	A	0.87 22.3	0.91 23.3	0.39 10.0	1.28 32.6	—	136	250
BF1719	in. mm	A	0.70 17.8	0.76 19.5	0.25 6.5	1.28 32.5	—	171	325
BF1835	in. mm	B	0.70 18.0	0.77 19.7	0.35 9.0	1.37 35.0	—	112	172
BF1125-5	in. mm	B	0.46 11.7	0.51 13.0	0.19 5.0	0.98 25.0	—	96	154
BF1125-3	in. mm	B	0.46 11.7	0.51 13.0	0.13 3.5	0.98 25.0	—	139	191
BF1429	in. mm	C	0.57 14.5	0.61 15.7	0.22 5.6	1.14 29.0	—	85	157
BF1225	in. mm	C	0.50 12.8	0.57 14.7	0.15 4.0	0.98 25.0	—	82	146
BF3024	in. mm	D	1.20 30.5	—	0.45 11.4	0.69 17.7	0.94 24.0	51	103
BF2125	in. mm	D	0.84 21.5	—	0.32 8.15	0.77 19.7	1.01 25.8	50	107
BF2123	in. mm	D	0.84 21.5	—	0.32 8.15	0.66 16.8	0.90 23.0	42	94
BF1835-9	in. mm	E	0.73 18.6	—	0.35 9.0	1.22 31.0	1.38 35.2	126	174
BF3121	in. mm	D	1.24 31.5	—	0.59 15.0	0.60 15.2	0.84 21.5	41	95

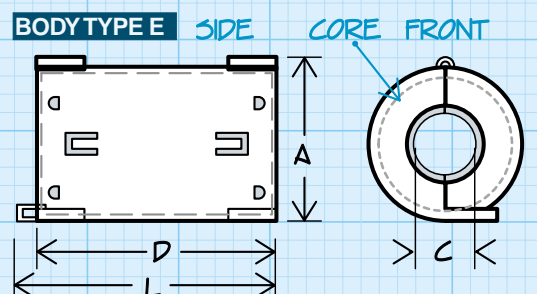
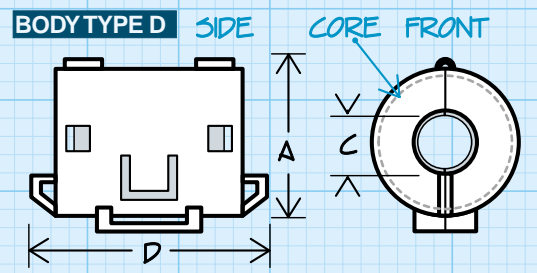
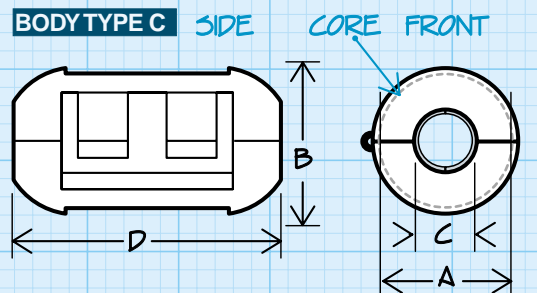
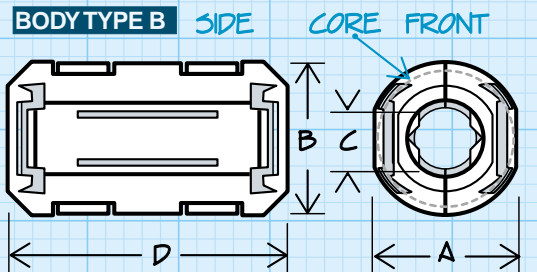
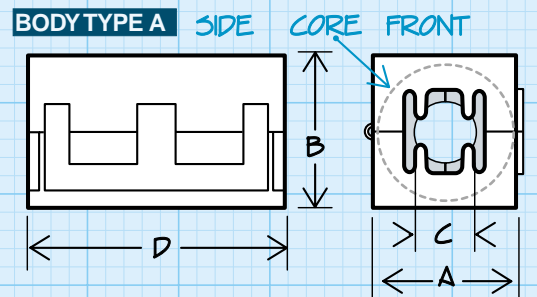

Physical Parameters

Material and U.L. Data API-1 Material, see characteristics and information on page 121.

* **Note** Impedance is typical, based on 1/2 turn (4.0") 18 AWG wire. Impedance measurement using HP4191A.

Color Black; Special colors Available for bases on a non-cancellable, non returnable basis C = Cream; W = White; Gr = Grey

U.L. Recognized

All plastic and adhesive components use U.L. Recognized materials with Flammability Ratings of UL94V-0, UL-510 or UL-746C

SEE Z vs. f GRAPHS ON NEXT PAGE

Split Ferrite Suppressors for Round Cables

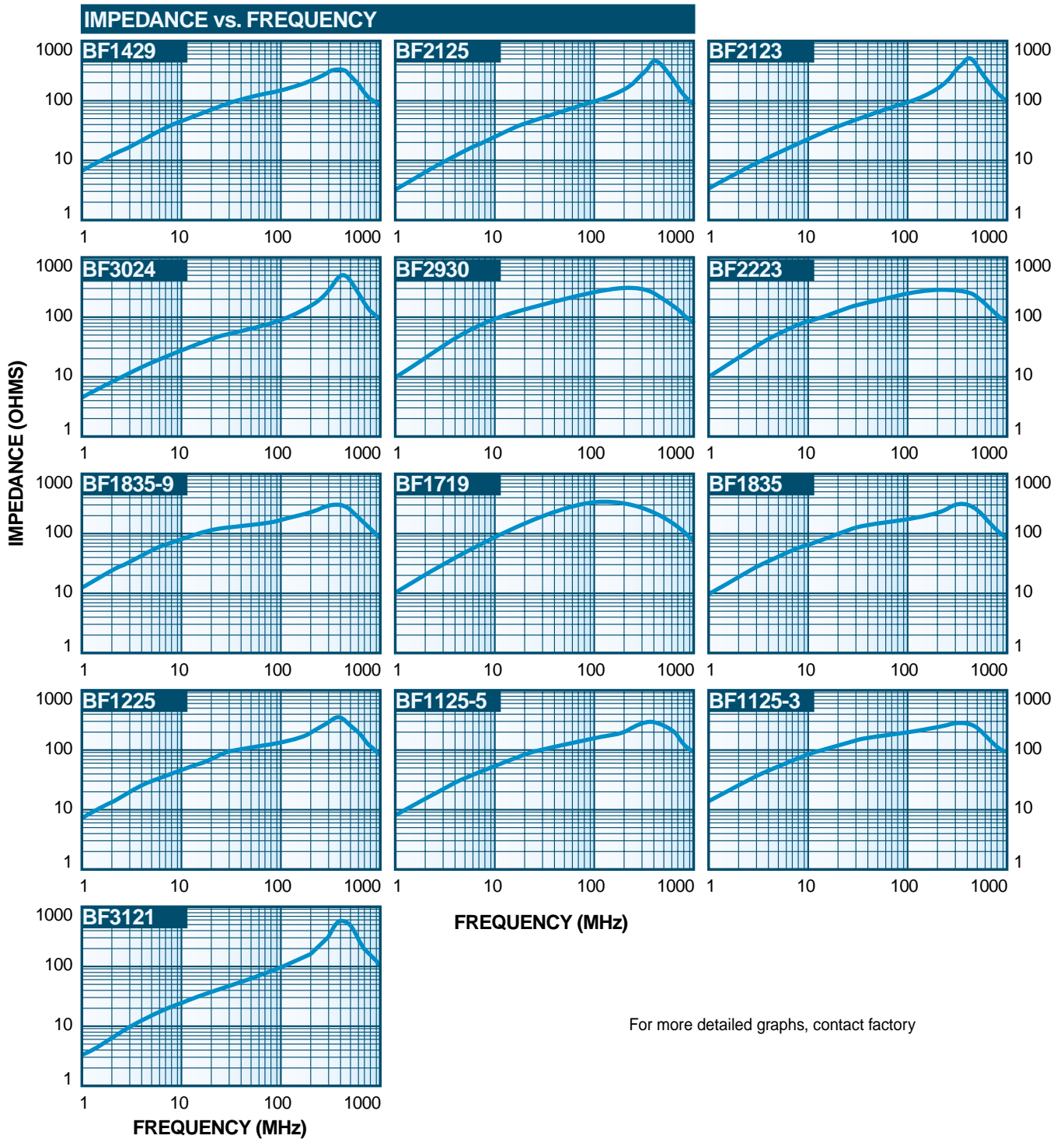

Additional Information on Preceding Pages

Note Impedance is typical, based on 1/2 turn (4.0") 18 AWG wire.
Impedance measurement using HP4191A